

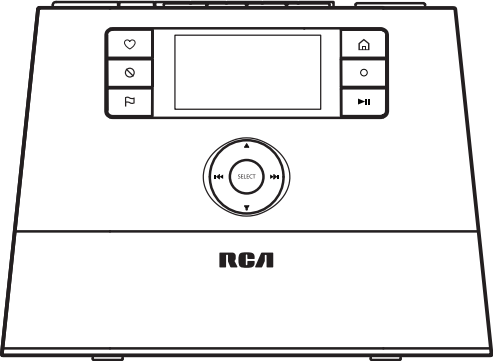

user manual

RIR200
RIR205



It is important to read this instruction book prior to using your new product for the first time.

Contents

Safety information	
Technical specification	3
Electrical power source	3
Product registration	4
For your records	4
Important battery precautions	4
Precautions for the player	4
IMPORTANT SAFETY INSTRUCTIONS	5
End user license agreement	
End user license agreement	6
Before you begin	
1. Unpack the unit	8
2. Setup your RCA Infinite Radio accounts	9
3. Insert AAA batteries in the base of the radio	9
4. For RIR205 only: Connect the RCA Wi-Fi Enabler to your network	9
5. Optional: Connect the radio using an Ethernet cable ...	10
6. Plug in and turn on the radio	10
7. Set up the radio	11
After connecting to the Internet	12
Demonstration mode	12
Getting the latest firmware and information	12
Frequently asked questions	13
General controls of RCA Wi-Fi Enabler (for RIR205)	13
Placement of Wi-Fi Enabler	14
General controls	
Front and top	15
Rear	15
Turning on or off	16
Volume control	16
Source selection	16
Weather forecast	16
Clock and alarm	16
Using the menus	16
Clock and alarm	
Accessing the digital clock	17
Setting the clock	17
Using the alarm clock	17
Sleep mode	18
Slacker Radio	
Accessing Slacker Radio	19
Listening to Slacker Radio	19
Tag Options	20
Internet Radio	
Accessing Internet Radio	21
Listening to Internet Radio	21
Recording Internet Radio	22
Adding Internet Radio stations	22
FM/AM Tuner	
FM/AM antenna	23
Accessing FM/AM Radio	23
Listening to FM/AM Radio	23
Recording FM/AM Radio	23
Internal Memory	
Accessing Internal Memory	24
Listening to recordings	24
Deleting recordings	24
USB Input	
Accessing USB Input mode	25
Listening to music files	25
Deleting files	25
Weather	
Weather broadcast	26
Emergency Broadcast System alert	26
Settings	
Changing radio's settings	27
Account info	27
Device info	27
Display	27
Network setup	27
Software updates	27
Weather	27
Advanced settings	27
More information	
Troubleshooting tips	28
Further help on Wi-Fi Enabler (for RIR205)	29
Web-based utility of Wi-Fi Enabler	31
Copyright warning	33
Check for updates	33
Technical specification	33
Specifications	33
Warranty information	
Limited warranty	34

Safety information

FCC information

This device complies with part 15 of the FCC rules. Operation is subject to the following two conditions: (1) This device may not cause harmful interference, and (2) This device must accept any interference received including interference which may cause undesired operation.



This equipment has been tested and found to comply with the limits for a Class B digital device, pursuant to Part 15 of the FCC Rules. These limits are designed to provide reasonable protection against harmful interference in a residential installation. This equipment generates, uses and can radiate radio frequency energy and, if not installed and used in accordance with the instructions, may cause harmful interference to radio communications. However, there is no guarantee that interference will not occur in a particular installation.

If this equipment does cause harmful interference to radio or television reception, which can be determined by turning the equipment off and on, the user is encouraged to try to correct the interference by one or more of the following measures:

- Reorient or relocate the receiving antenna.
- Increase the separation between the equipment and receiver.
- Connect the equipment into an outlet on a circuit different from that to which the receiver is connected.
- Consult the dealer or an experienced radio / TV technician for help.

In accordance with FCC requirements, changes or modifications not expressly approved by manufacturer could void the user's authority to operate this product.



 <p>THE LIGHTNING FLASH AND ARROWHEAD WITHIN THE TRIANGLE IS A WARNING SIGN ALERTING YOU OF "DANGEROUS VOLTAGE" INSIDE THE PRODUCT.</p>	CAUTION RISK OF ELECTRIC SHOCK DO NOT OPEN CAUTION: TO REDUCE THE RISK OF ELECTRIC SHOCK, DO NOT REMOVE COVER (OR BACK). NO USER-SERVICEABLE PARTS INSIDE. REFER SERVICING TO QUALIFIED SERVICE PERSONNEL.	 <p>THE EXCLAMATION POINT WITHIN THE TRIANGLE IS A WARNING SIGN ALERTING YOU OF IMPORTANT INSTRUCTIONS ACCOMPANYING THE PRODUCT.</p>
SEE MARKING ON BOTTOM / BACK OF PRODUCT		

WARNING: TO PREVENT FIRE OR ELECTRICAL SHOCK HAZARD, DO NOT EXPOSE THIS PRODUCT TO RAIN OR MOISTURE.

Manufacturer/Responsible Party

Audiovox Electronics Corp,
150 Marcus Blvd, Hauppauge, NY 11788
1-800-878-5779

This Class B digital apparatus complies with Canadian ICES-003.
Cet appareil numérique de la class B est conforme à la norme du NMB-003 du Canada.

Technical specification

Product: Wi-Fi Internet Radio
Brand: RCA
Model: RIR200, RIR205

Electrical power source

External AC adapter for radio
Output: 9.0V DC 1.56A
Input: 100-240V ~ 50/60Hz 0.7A

External AC adapter for enabler (RIR205 only)

Output: 5V DC 1A
Input: 100V~240V AC Power

Safety information

Product registration

Go to www.rcaaudiovideo.com for online registration.

For your records

Keep your sales receipt for proof of purchase to obtain warranty parts and service.

In the event that service should be required, you may need both the model number and the serial number. In the space below, record the date and place of purchase, and the serial number:

Model No.

Date of Purchase

Place of Purchase

Serial No.

Important battery precautions

- Any battery may present a risk of fire, explosion, or chemical burn if abused. Do not try to charge a battery that is not intended to be recharged, do not incinerate, and do not puncture.
- Non-rechargeable batteries, such as alkaline batteries, may leak if left in your product for a long period of time. Remove the batteries from the product if you are not going to use it for a month or more.
- If your product uses more than one battery, do not mix types and make sure they are inserted correctly. Mixing types or inserting incorrectly may cause them to leak.
- Discard any leaky or deformed battery immediately. They may cause skin burns or other personal injury.
- Please help to protect the environment by recycling or disposing of batteries according to federal, state, and local regulations.

Precautions for the player

- Do not use the unit immediately after transportation from a cold place to a warm place; condensation problems may result.
- Avoid shock to the unit.
- Do not store the unit near fire, places with high temperature or in direct sunlight. Exposure to direct sunlight or extreme heat (such as inside a parked car) may cause damage or malfunction.
- Do not expose to rain or moisture.
- Do not operate or store unit in places with frequent static electricity or electrical noise (e.g. speaker, TV set).
- Clean the unit with a soft cloth or a damp chamois leather. Never use solvents.
- The unit must only be opened by qualified personnel.

Safety information

IMPORTANT SAFETY INSTRUCTIONS

PLEASE READ AND SAVE FOR FUTURE REFERENCE

Some of the following information may not apply to your particular product; however, as with any electronic product, precautions should be observed during handling and use.

- Read these instructions.
- Keep these instructions.
- Heed all warnings.
- Follow all instructions.
- Do not use this apparatus near water.
- Clean only with dry cloth.
- Do not block any ventilation openings. Install in accordance with the manufacturer's instructions.
- Do not install near any heat sources such as radiators, heat registers, stoves, or other apparatus (including amplifiers) that produce heat.
- Do not defeat the safety purpose of the polarized or grounding-type plug. A polarized plug has two blades with one wider than the other. A grounding type plug has two blades and a third grounding prong. The wide blade or the third prong is provided for your safety. If the provided plug does not fit into your outlet, consult an electrician for replacement of the obsolete outlet.
- Protect the power cord from being walked on or pinched particularly at plugs, convenience receptacles, and the point where they exit from the apparatus.
- Only use attachments/accessories specified by the manufacturer.
- Use only with the cart, stand, tripod, bracket, or table specified by the manufacturer, or sold with the apparatus. When a cart is used, use caution when moving the cart/apparatus combination to avoid injury from tip-over.



Portable Cart Warning

- Unplug this apparatus during lightning storms or when unused for long periods of time.
- Refer all servicing to qualified service personnel.

Servicing is required when the apparatus has been damaged in any way, such as power-supply cord or plug is damaged, liquid has been spilled or objects have fallen into the apparatus, the apparatus has been exposed to rain or moisture, does not operate normally, or has been dropped.

• **ADDITIONAL SAFETY INFORMATION**

- Apparatus shall not be exposed to dripping or splashing and no objects filled with liquids, such as vases, shall be placed on the apparatus.
- Always leave sufficient space around the product for ventilation. Do not place product in or on a bed, rug, in a bookcase or cabinet that may prevent air flow through vent openings.
- Do not place lighted candles, cigarettes, cigars, etc. on the product.
- Connect power cord only to AC power source as marked on the product.
- Care should be taken so that objects do not fall into the product.
- Do not attempt to disassemble the cabinet. This product does not contain customer serviceable components.
- MAINS plug or an appliance coupler is used as the disconnect device, the disconnect device shall remain readily operable.
- **IF YOUR PRODUCT OPERATES ON BATTERIES,** adhere to the following precautions:
 - A. Any battery may leak electrolyte if mixed with a different battery type, if inserted incorrectly, or if all batteries are not replaced at the same time.
 - B. Any battery may leak electrolyte or explode if disposed of in fire or an attempt is made to charge a battery not intended to be recharged.
 - C. Discard leaky batteries immediately. Leaking batteries can cause skin burns or other personal injury. When discarding batteries, be sure to dispose of them in the proper manner, according to your state/provincial and local regulations.
 - D. Batteries (battery pack or batteries installed) shall not be exposed to excessive heat such as sunshine, fire or the like.

End user license agreement

End user license agreement

IMPORTANT: READ CAREFULLY BEFORE DOWNLOADING OR INSTALLING THIS SOFTWARE!

THIS END USER LICENSE AGREEMENT (THIS "EULA") IS A LEGAL AGREEMENT BETWEEN YOU AND AUDIOVOX CORPORATION AND, AS APPLICABLE, ANY AUDIOVOX SUBSIDIARY, AS DEFINED BELOW (COLLECTIVELY "AUDIOVOX"), FOR THE RCA® BRAND INTERNET RADIO DEVICE APPLICATION/DRIVER SOFTWARE PROGRAM WHICH MAY INCLUDE ASSOCIATED SOFTWARE COMPONENTS, SOFTWARE LICENSED BY AUDIOVOX FROM THIRD PARTIES ("LICENSORS") AND ASSOCIATED DOCUMENTATION, IF ANY (COLLECTIVELY, THE "PROGRAM"). THIS EULA CONTAINS IMPORTANT LEGAL LIMITATIONS, RESTRICTIONS AND DISCLAIMERS, AND ALSO SPECIFIES THE DURATION OF YOUR LICENSE. BY INSTALLING THE PROGRAM OR CLICKING ON THE ACCEPTANCE BUTTON OF THE PROGRAM, COPYING OR OTHERWISE USING THE PROGRAM, YOU ACKNOWLEDGE AND AGREE THAT YOU HAVE READ THIS EULA, UNDERSTAND IT, AND AGREE TO BE BOUND BY ITS TERMS AND CONDITIONS. THIS PROGRAM IS PROTECTED BY COPYRIGHT LAWS AND INTERNATIONAL COPYRIGHT TREATIES, AS WELL AS OTHER INTELLECTUAL PROPERTY LAWS AND TREATIES. YOU MAY USE THE PROGRAM ONLY IN ACCORDANCE WITH THIS EULA, AND ANY SUCH USE IS HEREBY UNDERSTOOD TO BE CONDITIONAL UPON YOUR SPECIFIC AGREEMENT TO THE UNMODIFIED TERMS SET FORTH HEREIN. IF YOU DO NOT AGREE WITH ALL OF THE TERMS OF THIS EULA, CLICK ON THE REJECTION BUTTON AND/OR DO NOT INSTALL THE PROGRAM AND/OR DO NOT USE THE PROGRAM.

1. LICENSE

- (a) Under this EULA, you are granted a non-exclusive, non-sublicensable, non-assignable and non-transferable (except as expressly set forth below) license (i) to use and install the Program on a single workstation, and (ii) to make one (1) copy of the Program into any machine-readable form for backup of the Program, provided the copy contains all of the original Program's proprietary notices.
- (b) You may transfer the Program and license to another party only as a part of the RCA® brand Internet Radio Device (the "Device"), and only if the other party agrees to accept the terms and conditions of this EULA. If you transfer the Program, you must at the same time either transfer all copies to the same party or destroy any copies not transferred.
- (c) The terms of this EULA will govern any software upgrades or updates provided by AUDIOVOX that replace and/or supplement the original Program, unless such upgrade or update is accompanied by separate license terms and conditions in which case the terms of that separate license will govern. You acknowledge and agree that AUDIOVOX may automatically download upgrades or updates to the Program software to your computer in order to update, enhance, and/or further develop the Program.

2. LICENSE RESTRICTIONS

- (a) Except for the licenses expressly granted to you in this EULA, no other licenses or rights are granted or implied.
- (b) You may not (i) make the Program available over a network where it could be used by multiple computers at the same time; (ii) modify, translate, reverse engineer, decompile, disassemble (except to the extent that this restriction is expressly prohibited by law), or create derivative works based upon the Program; (iii) copy the Program, except as expressly permitted herein; (iv) remove or alter any copyright notices on all copies of the Program; or (v) rent, lease or lend the Program. You agree that you shall only use the Program in a manner that complies with all applicable laws in the jurisdictions in which you use the Program, including, but not limited to, applicable restrictions concerning copyright and other intellectual property rights.

- (c) The Program may contain pre-release code that does not perform at the level of a final code release. In such case, the Program may not operate properly. Updated versions of the Program may be downloaded from www.rcaaudiovideo.com/downloads
- (d) AUDIOVOX is not obligated to provide support services for the Program.
- (e) The Program is provided with "RESTRICTED RIGHTS". Use, duplication, or disclosure by the U.S. Government is subject to restrictions as set forth in subparagraph (c)(1)(ii) of DFARS 252.227-7013, or FAR 52.227-19, or in FAR 52.227-14 Alt. III, as applicable.

3. TERM AND TERMINATION

- (a) Your license is effective on the date you accept this EULA and remains in effect until this EULA is terminated by either party.
- (b) You may terminate this EULA and the associated license, without any notice or delay, by destroying or permanently erasing the Program and all copies thereof.
- (c) If you fail to comply with any of the terms of this EULA, in whole or part, your license will automatically terminate without notice from AUDIOVOX.
- (d) Upon termination of this EULA and your associated license, you shall cease all use of the Program and destroy or permanently erase the Program and all full or partial copies thereof.

4. WARRANTY DISCLAIMER

THE PROGRAM IS PROVIDED "AS IS" WITHOUT WARRANTY OF ANY KIND, EITHER EXPRESSED OR IMPLIED, INCLUDING, BUT NOT LIMITED TO THE IMPLIED WARRANTIES OF MERCHANTABILITY, FITNESS FOR A PARTICULAR PURPOSE, TITLE OR NON-INFRINGEMENT. THE ENTIRE RISK AS TO THE QUALITY AND PERFORMANCE OF THE PROGRAM IS WITH YOU. SHOULD THE PROGRAM PROVE DEFECTIVE, YOU (AND NOT AUDIOVOX, ITS LICENSORS, SUPPLIERS, OR ITS DEALERS) ASSUME THE ENTIRE COST FOR ALL NECESSARY REPAIR OR CORRECTION.

This exclusion of warranty may not be allowed under some applicable laws. As a result, the above exclusion may not apply to you, and you may have other rights depending on the law that applies to you.

5. OWNERSHIP RIGHTS

All title and intellectual property rights, including but not limited to copyrights, in and to the Program and any copies thereof are owned by AUDIOVOX, its Licensors or its suppliers. All title and intellectual property rights in and to the content which may be accessed through use of the Program is the property of the respective content owner and may be protected by applicable copyright or other intellectual property laws and treaties. This license grants you no rights to use such content. All rights not expressly granted are reserved by AUDIOVOX or its Licensors.

6. LIMITATION OF LIABILITY

- (a) TO THE MAXIMUM EXTENT PERMITTED BY APPLICABLE LAW, IN NO EVENT SHALL AUDIOVOX, ITS LICENSORS, OR ITS DEALERS BE LIABLE FOR ANY SPECIAL, INCIDENTAL, INDIRECT, OR CONSEQUENTIAL DAMAGES WHATSOEVER (INCLUDING, WITHOUT LIMITATION, DAMAGES FOR LOSS OF PROFITS, BUSINESS INTERRUPTION, CORRUPTION OF FILES, LOSS OF BUSINESS INFORMATION, OR ANY OTHER PECUNIARY LOSS) REGARDLESS OF CAUSE OR FORM OF ACTION, INCLUDING CONTRACT, TORT, OR NEGLIGENCE, ARISING OUT OF YOUR USE OF OR INABILITY TO USE THE PROGRAM, EVEN IF AUDIOVOX HAS BEEN ADVISED OF THE POSSIBILITY OF SUCH DAMAGES. BECAUSE SOME STATES AND JURISDICTIONS DO NOT ALLOW THE EXCLUSION OR LIMITATION OF LIABILITY OF CONSEQUENTIAL OR INCIDENTAL DAMAGES, THE ABOVE LIMITATION MAY NOT APPLY TO YOU.

End user license agreement

(b) YOU ASSUME RESPONSIBILITY FOR THE SELECTION OF THE APPROPRIATE PROGRAM TO ACHIEVE YOUR INTENDED RESULTS, AND FOR THE INSTALLATION, USE, AND RESULTS OBTAINED.

7. WINDOWS MEDIA

This product is protected by certain intellectual property rights of Microsoft. Use or distribution of such technology outside of this product is prohibited without a license from Microsoft.

The software embedded within your Device (the "Device Firmware") contains software licensed from Microsoft that enables you to play Windows Media Audio (WMA) files ("WMA Software"). The WMA Software is licensed to you for use with your Device under the following conditions. By installing and using this version of the Device Firmware, you are agreeing to these conditions. IF YOU DO NOT AGREE TO THE END USER CONDITIONS OF THIS SECTION 7, DO NOT INSTALL OR USE THIS VERSION OF THE DEVICE FIRMWARE.

The WMA Software is protected by copyright and other intellectual property laws. This protection also extends to documentation for the WMA Software, whether in written or electronic form.

GRANT OF LICENSE. The WMA Software is only licensed to you as follows:

You may use this version of the Device Firmware containing the WMA Software only as such use relates to your Device.

You may not reverse engineer, decompile, or disassemble the WMA Software, except and only to the extent that such activity is expressly permitted by applicable law.

You may transfer your right to use the Device Firmware only as part of a sale or transfer of your Device, on the condition that the recipient agrees to the conditions set forth herein. If the version of the Device Firmware that you are transferring is an upgrade, you must also transfer all prior versions of the Device Firmware that you have which include the WMA Software.

MICROSOFT IS NOT PROVIDING ANY WARRANTY OF ANY KIND TO YOU FOR THE WMA SOFTWARE, AND MICROSOFT MAKES NO REPRESENTATION CONCERNING THE OPERABILITY OF THE WMA SOFTWARE.

The WMA Software is of U.S. origin. Any export of this version of the Device Firmware must comply with all applicable international and national laws, including the U.S. Export Administration Regulations, that apply to the WMA Software incorporated in the Device Firmware.

8. RealNetworks, Inc.

Portions of this software are included under license from RealNetworks, Inc. Copyright 1995-2007, RealNetworks, Inc. All rights reserved.

The portions of the Program licensed from RealNetworks, Inc. ("RN") are provided AS IS WITHOUT WARRANTY OF ANY KIND. TO THE MAXIMUM EXTENT PERMITTED BY APPLICABLE LAW, RN FURTHER DISCLAIMS ALL WARRANTIES, EXPRESS AND IMPLIED, INCLUDING WITHOUT LIMITATION ANY IMPLIED WARRANTIES OF MERCHANTABILITY, FITNESS FOR A PARTICULAR PURPOSE, AND NON-INFRINGEMENT. TO THE MAXIMUM EXTENT PERMITTED BY LAW IN NO EVENT SHALL RN BE LIABLE FOR ANY CONSEQUENTIAL, INCIDENTAL, INDIRECT, SPECIAL, PUNITIVE OR OTHER DAMAGES (INCLUDING, WITHOUT LIMITATION, DAMAGES FOR LOSS OF PROFITS). BECAUSE SOME STATES AND JURISDICTIONS DO NOT ALLOW THE EXCLUSION OR LIMITATION OF LIABILITY OF CONSEQUENTIAL OR INCIDENTAL DAMAGES, THE ABOVE LIMITATION MAY NOT APPLY TO YOU.

You may not modify, translate, reverse engineer, decompile, disassemble (except to the extent that this restriction is expressly prohibited by applicable law) or use other means to discover the RN Source Code or otherwise replicate the functionality of the Real Format Client Code.

9. THIRD PARTY SOFTWARE

ANY THIRD PARTY SOFTWARE THAT MAY BE PROVIDED WITH THE PROGRAM IS INCLUDED FOR USE AT YOUR OPTION. IF YOU CHOOSE TO USE SUCH THIRD PARTY SOFTWARE, THEN SUCH USE SHALL BE GOVERNED BY SUCH THIRD PARTY'S LICENSE AGREEMENT, AN ELECTRONIC COPY OF WHICH WILL BE INSTALLED IN THE APPROPRIATE FOLDER ON YOUR COMPUTER UPON INSTALLATION OF THE SOFTWARE. AUDIOVOX IS NOT RESPONSIBLE FOR ANY THIRD PARTY'S SOFTWARE AND SHALL HAVE NO LIABILITY FOR YOUR USE OF THIRD PARTY SOFTWARE.

10. GOVERNING LAW

If you acquired this Device in the United States, this EULA shall be governed and construed in accordance with the laws of the State of New York, U.S.A. without regard to its conflict of laws principles. If you acquired this Device outside the United States or the European Union, then local law may apply.

11. GENERAL TERMS

This EULA can only be modified by a written agreement signed by you and AUDIOVOX, and changes from the terms and conditions of this EULA made in any other manner will be of no effect. If any portion of this EULA shall be held invalid, illegal, or unenforceable, the validity, legality, and enforceability of the remainder of the Agreement shall not in any way be affected or impaired thereby. This EULA is the complete and exclusive statement of the agreement between you and AUDIOVOX, which supersedes all proposals or prior agreements, oral or written, and all other communications between you and AUDIOVOX, relating to the subject matter of this hereof. AUDIOVOX'S Licensors shall be considered third party beneficiaries of this Agreement and shall have the right to enforce the terms herein.

"AUDIOVOX SUBSIDIARY" shall mean any person, corporation, or other organization, domestic or foreign, including but not limited to subsidiaries, that is directly or indirectly controlled by Audiovox Corporation including, but not limited to, Audiovox Consumer Electronics, Inc. and Audiovox Electronics Corporation. For purposes of this definition only, the term "control" means the possession of the power to direct or cause the direction of the management and policies of an entity, whether by ownership of voting stock or partnership interest, by contract, or otherwise, including direct or indirect ownership of at least fifty percent (50%) of the voting interest in the entity in question.

Before you begin

Dear RCA customer,

Thank you for purchasing the RCA Wi-Fi Internet Radio. This product will let you listen to Slacker™ Radio, Internet Radio, AM/FM tuner, weather forecast and music stored in the internal memory or a USB device.

To start using your Wi-Fi Internet Radio, please follow the setup instructions in the following pages.

1. Unpack the unit

You should find the following items in the box:

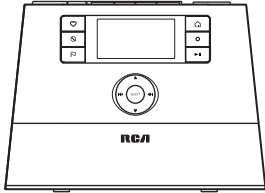

Radio



Power adapter

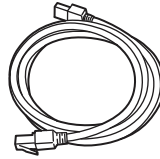

Ethernet cable



AM loop antenna



Quick Start
Guide

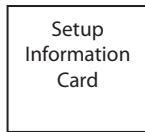

Setup
Information
Card

For RIR205 only:

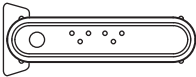

Wi-Fi Enabler



Power adapter

Additional requirements

- Broadband Internet service
- Broadband (cable/DSL) modem, usually supplied by your Internet service provider
- An 802.11 b or g (Wi-Fi) wireless home network or Ethernet router/switch/hub with available LAN port

For Wi-Fi connections, you may also need:

- Your wireless network's SSID
- Your access password (for secure networks)

Before you begin

2. Setup your **RCA Infinite Radio** accounts

To simplify setup on the radio please complete these steps:

1. Find the Setup Information Card that contains your radio's MAC address number (MAC: 00-00-00-00-00-00) and activation PIN # (PIN: 0000). (This number is also found in the Device Info screen under the Settings menu in your radio.)
2. Using any Internet-connected computer, go to **www.rcainfiniteradio.com/setup** and follow the online instructions.
- You will need to input your radio's MAC address and PIN # to associate your radio with your personal settings.

3. Optional: Insert AAA batteries in the base of the radio

Follow the polarity markers in the battery compartment. The batteries power the clock and alarm* whenever the radio loses electricity. We recommend that you replace the batteries every year (or more often in case of multiple power outages) to avoid low battery power. Otherwise, clock and alarm accuracy may be affected when electricity supply is interrupted.

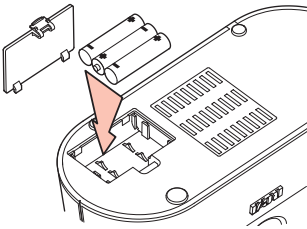

* When the battery backup functions, the clock display will not light. However, the function of alarm still occurs during the power interruption if remaining battery power is adequate.

4. For **RIR205** only: Connect the RCA Wi-Fi Enabler to your network

If your modem or router/hub/switch has only one LAN port and is connected to your PC, disconnect the Ethernet cable from the modem/router/hub/switch and connect it to the Enabler's LAN port.

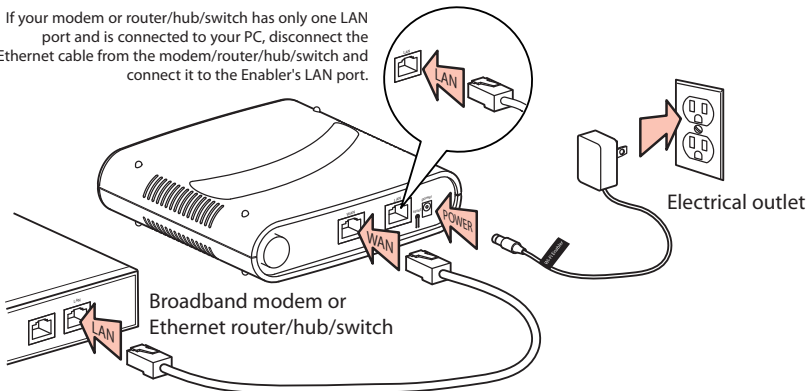

- Make sure the power, WAN, and WIRELESS LEDs are on. The MODE LED state will vary depending on your network configuration. If the MODE, WPS, and WIRELESS LEDs are blinking simultaneously, this indicates a possible connection error. Please review your connections and then press and hold the Enabler's **WPS** button for 3 seconds (the MODE LED should start blinking) to rescan your network configuration. The Enabler may restart multiple times during this process and take up to two minutes depending on your network configuration. The MODE LED will stop blinking when this process is completed. Go to **www.rcainfiniteradio.com** for more information.

Before you begin

5. Optional: Connect the radio using an Ethernet cable

Use the Ethernet cable if you do not have a wireless (Wi-Fi) access point.

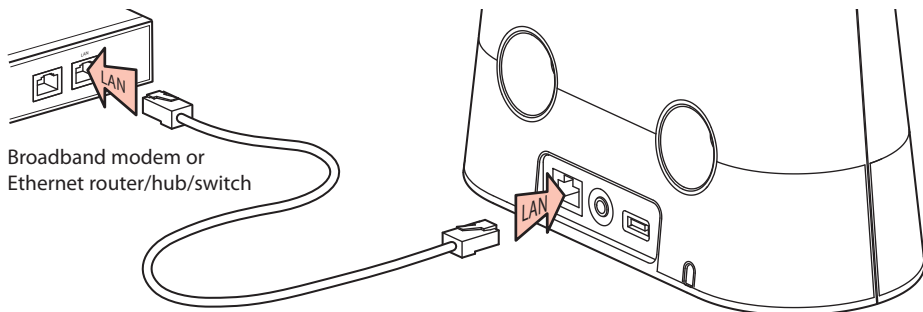

6. Plug in and turn on the radio

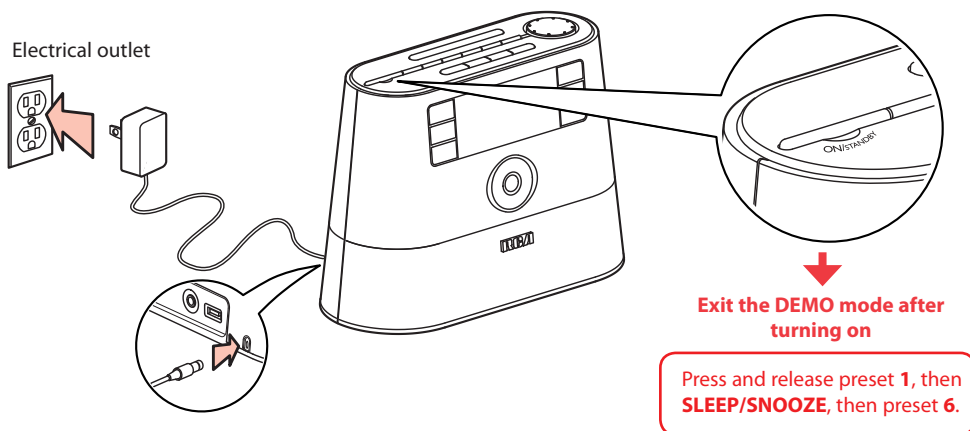

Before you begin

7. Set up the radio

Refer to **Using the menus** on page 16 for more information on making choices and inputting information in menus.



- A. **NOTE:** When you turn on the radio for the first time, it will be in "DEMO" mode. To exit this mode, press and release preset **1**, then **SLEEP/SNOOZE**, then preset **6** on top of the radio.
- B. After exiting the DEMO mode, the radio displays the **Select Language** screen. Press **▲** or **▼** to choose your language and then press **SELECT**.

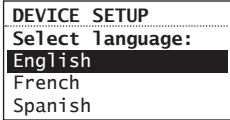

- **If you are using RCA Wi-Fi Enabler (RIR205), setup is done** (except you may need to enter your Zip code).
- If you encounter problems to connect the radio to the Internet via RCA Wi-Fi Enabler, refer step 4 on page 9 or page 29 **Further help on Wi-Fi Enabler**.
- If you are using your own access point or router, please read below.

- 3. The **Network Setup** screen displays connection options:

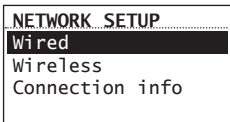

- Select **Wired** to connect using an Ethernet cable. **Go to step 4 to complete the connection.**
- Select **Wireless** to connect using an existing Wi-Fi access point. **Go to step 5 to complete the connection.**

4. Wired

This method uses an Ethernet cable shown in step 5 on page 10 to wire the radio directly up to your broadband modem, router, hub, or switch. Make sure your Ethernet cable is properly connected.

- At the **Network Setup** screen, press **▲** or **▼** to select **Wired** and then press **SELECT** if your network does not provide Wi-fi access.

- Before the connection is complete, the radio may take some time to check for updates and retrieve account info from the server. Please wait until you hear a short congratulations message and "Setup is complete, enjoy the music" is displayed.
- If the radio requires your IP address, you can find this information on your broadband modem, router or access point's administration setup page or manual.

5. Wireless

This method uses your existing Wi-Fi access point, broadband modem or router to connect the radio to your existing network. You need to know your Wireless Network's name (SSID) and if your wireless network has security enabled, you will also need to know your wireless networks password (sometimes called passphrase or key). You can find this information on your broadband modem, router or access point's administration setup page or manual. You may also call your Internet Service Provider (ISP) if you do not know how to access the administration page in order to find this information. They usually have a 1-800 number available. Once you have the below information you may write it down for future reference.

- **Wireless network name (SSID)**
- **Security Type** (Only needed if your network has security enabled and your SSID is hidden, not broadcasted)
- **Password/Key** (Only needed if your network has security enabled)

At the **Network Setup** screen, press **▲** or **▼** to select **Wireless** and then press **SELECT**. The **Network Setup** screen then shows with two setup options. Press **▲** or **▼** to choose an option and then press **SELECT**.

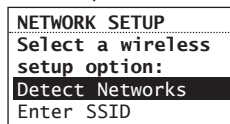

- **Detect Networks:** to automatically scan for available networks and display a list of networks to choose from. **Go to step 6 to complete the connection.**

Before you begin

- **Enter SSID:** to manually enter your networks information. Select this option if your Networks SSID is hidden. **Go to step 7 to complete the connection.**
- 6. If **Detect Networks** is selected, the SSID (network name) of those found will be displayed after searching. Press ▲ or ▼ to select a desired network and then press **SELECT**.

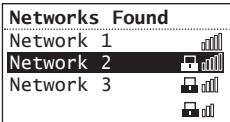

- Signal strength is indicated by 📶.
- Secured network is indicated by 🔒 (unsecured network has none, as Network 1 in the above example).
- If a secured network is selected, you will be required to enter your password in the **Network Security** screen. The radio should then connect to the Internet. Please wait until you hear a short congratulations message and the clock screen is displayed.

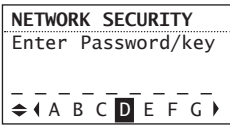

- If the network SSID is hidden (not broadcasted), you will only see a padlock icon and signal strength bars like the 4th network shown above. Press ▼ to highlight **Enter SSID** on the display and then press **SELECT**. Then go to step 7 to complete your connection.
- Interference may sometimes block your network from showing up in the list. If this happens, press ▼ to show **Refresh List** and then press **SELECT** to try again.
- 7. If **Enter SSID** is selected, the **Network Security** screen will be displayed. Enter your SSID.

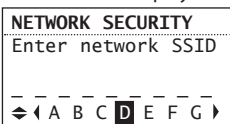

- If your network is secured (indicated by 🔒), enter your password. The radio should then connect to the Internet. Please wait until you hear a short congratulations message and the clock screen is displayed.

About password:

- Do not get your Network Password confused with your Windows or Mac system logon password since they can be different.
- Some wireless access point or routers may call the Wireless Network Password a passphrase or key. These terms are the same.

About passphrase:

- This radio supports secured access points using the Wireless Equivalent Privacy (WEP) keys or Wi-Fi Protected Access (WPA and WPA2) standards.
- WEP keys are either 10 or 26 characters long (characters: 0-9 and A-F) (e.g. 6E78214A52). Note that some Wi-Fi routers support passphrase generation for WEP security. However, there is no industry standard for WEP passphrase generation and this radio does not support WEP passphrases.
- If you are using a WEP secured access point, enter the WEP key (HEX format) instead of the passphrase.

After connecting to the Internet

- If you did not activate your Infinite Radio accounts, or if the radio cannot get your details from the Infinite Radio server, the radio may ask for your ZIP code.
- Input your ZIP. The radio should then connect to Internet Radio.

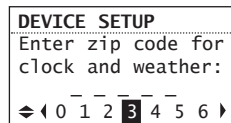

Demonstration mode

The radio has a pre-installed demonstration. To exit the demonstration, press and release in sequence the buttons on top of the radio: preset **1**, then **SLEEP/SNOOZE**, then preset **6**.

Getting the latest firmware and information

The radio will automatically alert you for upgrade if a new firmware is available. You may also go to **www.rcainfiniteradio.com** for the latest firmware and user manual for your radio. Follow the instructions there to download and install files.

Before you begin

Frequently asked questions

For answers to frequently asked questions (FAQ's), go to www.rcainfiniterradio.com.

General controls of RCA Wi-Fi Enabler (for RIR205)

Front view

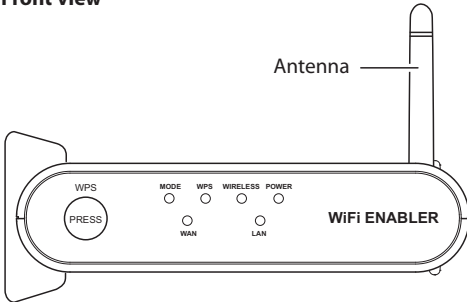

Back view

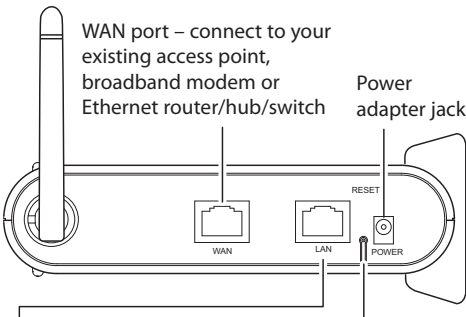

- LAN port – if your modem or router/hub/switch has only one LAN port and is connected to your PC, disconnect the Ethernet cable from the modem/router/hub/switch and connect it to the Enabler's LAN port.
- You can also connect it to your computer's Ethernet port to access the Enabler's web-administration page for troubleshooting purposes. Refer to page 31 for more information.

To install the Enabler:

The Enabler can be installed vertically or horizontally. Remove the standing brackets for horizontal installation. Rotate the antenna to improve signal reception.

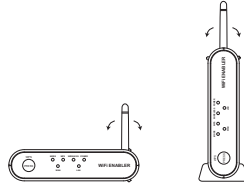

To turn on the Wi-Fi Enabler:

The Enabler will turn on automatically when power is connected.

To check the RCA Wi-Fi Enabler's status by reading the LEDs (Lights):

- Normally the POWER, WAN and WIRELESS LEDs will be on when the enabler is operating as a router.
- The LAN LED will be on if there is an Ethernet cable connected from the LAN port on the Enabler to a computer.
- The MODE LED will be off when the Enabler is operating as a Router.
- The MODE LED will be on when the Enabler is operating as an (AP) Access Point.

To rescan the network configuration:

- Your Wi-Fi Enabler comes preconfigured from the factory so normally no rescan should be necessary.
- Press and hold the **WPS** key for 3 seconds. The MODE LED then starts blinking. This will indicate to the user that the unit is scanning the network to determine the correct mode for the new environment (i.e. either router or AP).
- If during a scanning, the unit cannot determine the mode or needs more information (i.e. no response from the WAN connection, PPPOE, fixed IP address connection, etc) the unit will start flashing the MODE, WPS and WIRELESS LEDs.

To reset the Enabler:

- If you are unable to connect the radio to the Wi-Fi enabler, press and hold the **RESET** for 10 seconds to reset the Wi-Fi enable back to factory defaults. After resetting the Wi-Fi enabler, try connecting again.

Before you begin

Placement of Wi-Fi Enabler

The placement of the RCA Wi-Fi Enabler and also interference can affect the radio and Wi-Fi Enablers operation; therefore choose placement wisely and try to reduce interference in the beginning will ensure a pleasant experience.

To choose Wi-Fi Enabler placement:

For best results, place your RCA Wi-Fi Enabler:

- Near the center of the area in which your computer and radio will operate.
- In an elevated location such as a high shelf where the wirelessly connected radio have line-of-sight access (even if through walls).
- Avoid obstacles to wireless signals.
- Keep wireless devices at least 2 feet (0.6m) from large metal fixtures such as file cabinets, refrigerators, pipes, metal ceilings, reinforced concrete, and metal partitions.
- Keep wireless devices away from large amounts of water such as fish tanks and water coolers.

To reduce interference:

- Avoid windows unless communicating between buildings.
- Place wireless devices away from various electromagnetic noise sources, especially those in the 2400 – 2500 MHZ frequency band.
Common noise-creating sources are:
 - 2.4 and 2.5GHz cordless phones, computers, other wireless routers, access points and fax machines (no closer than 1 foot (0.3m)).
 - Copying machines, elevators, and cell phones (no closer than 6 feet (1.8m)).
 - Microwave ovens (no closer than 10 feet (3m)).

General controls

Front and top

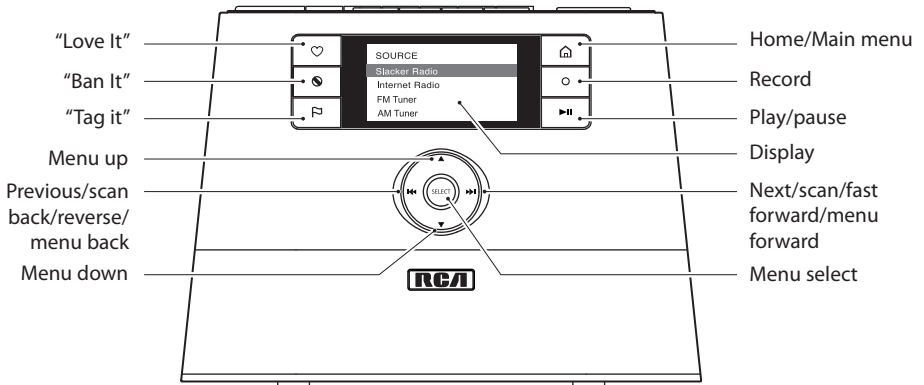
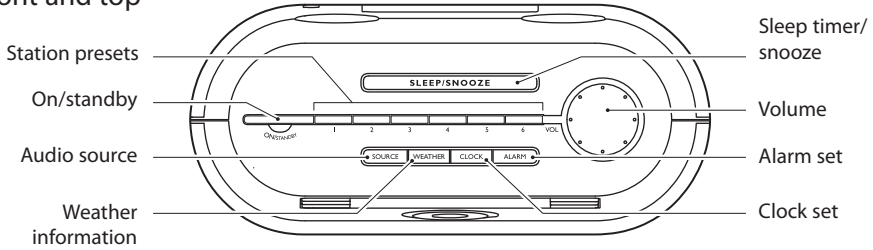

Rear

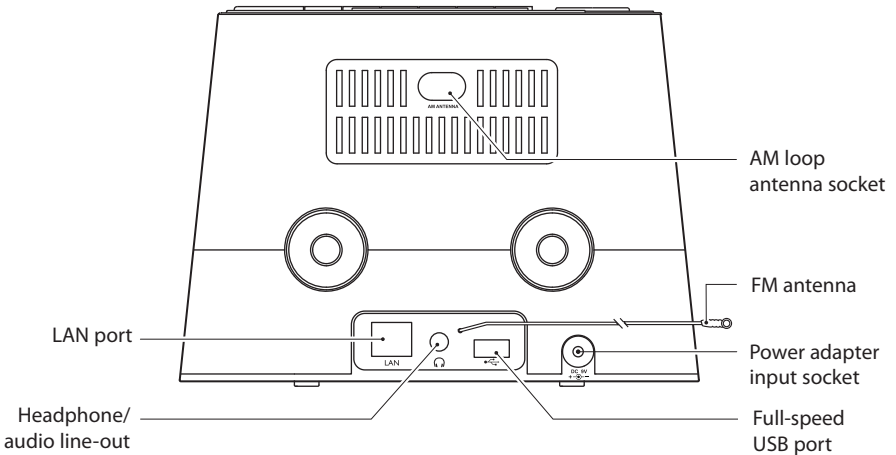

You can connect USB devices to the USB port: The radio can play MP3, WMA and RealAudio audio files stored on the connected USB device.

General controls

Turning on or off

Press **ON/STANDBY** to turn the radio on or off (standby mode).

Volume control

Rotate the **VOL.** knob to adjust the volume.

Source selection

Press **SOURCE** repeatedly to select among the following audio content sources:

- Slacker Radio, Internet Radio, USB Input, Internal Memory, FM Tuner, AM Tuner

Weather forecast

Press **WEATHER** to check current and 3-day forecast. Refer to page 26 for more information.

Clock and alarm

- Press **CLOCK** once to show the current time or press and hold to set the clock time.
- Press **ALARM** once to activate or deactivate the alarm clock or press and hold to set the alarm.
- Refer to page 17-18 for more information.

Using the menus

The display window shows the playback screen, browse screen, settings screen, messages etc. What appears on the window varies depending on the function you are using.

To display the Source menu:

- Press **SOURCE** to display the Source menu for selection of an audio source.
- **Now Playing** – appears at the top of the Source menu when a station is playing. Select this option to return to the play screen.

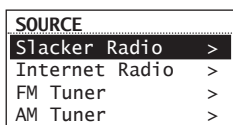

To navigate in the menus:

- Use the navigation controls to make choices and input information.



▲	Moves highlight up
▼	Moves highlight down
◀	Moves selection/navigates left
▶	Moves selection/navigates right
SELECT	Confirms selected option or character

To input characters:

- Some menus require character input (e.g. password, ZIP code). ZIP code is useful for clock time setting, weather forecast and searching local Internet radio stations in your area.
- When inputting characters, press ◀ or ▶ to select the alpha-numeric characters listed at the bottom of the screen. Press **SELECT** to confirm selections.
- Press ▲ or ▼ to choose among uppercase, lowercase, numeric, special characters or commands.



Character sets (▲ or ▼)	Options (◀ or ▶)
Upper case	A B C D E...X Y Z
Lower case	a b c d e...x y z
Numeric	1 2 3 4 5 6 7 8 9 0
Special	_ - ! @ # \$ % ^ & *
Commands	(read below)

- Commands: press ◀ or ▶ (or ▲ or ▼) to choose the desired command and then press **SELECT**.

Commands	Actions
DONE	Ends entry
Delete	Deletes highlighted input and moves the highlight back one space
Space	Inserts a blank space, characters to the right will move one location over
Back	Moves the highlight back within the entered character without deleting
Next	Moves the highlight forward within the entered character without deleting
Cancel	Exits input screen without changes

To exit the input screen without saving, select the **Cancel** command.



Clock and alarm

Accessing the digital clock

The Wi-Fi Internet Radio also includes a digital clock which will be automatically updated when connected with the Internet.

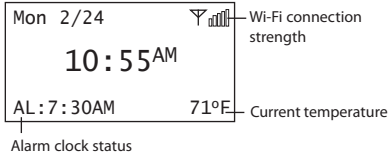

- Press **CLOCK** to show the clock without interrupting audio playback.
- To hide the clock and return the display to the previous screen, press **CLOCK** again.
- The clock is also displayed when the radio is turned off (standby mode).

Setting the clock

With your ZIP code set, the clock time will be automatically updated when connected with the Internet. However, you may still be able to set it manually. Day, date and month can only be updated by connecting with an Internet radio station.

1. Press and hold **CLOCK** until the hour time is highlighted (reversed color) on the display.

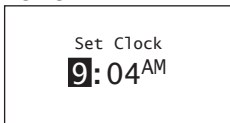

2. Press **▲** or **▼** to select the hour time.
3. Press **▶▶** to shift to minute time.
4. Press **▲** or **▼** to select the minute time.
5. Press **▶▶** to shift to AM/PM.
6. Press **▲** or **▼** to select between AM and PM.
7. Press **SELECT** again to confirm the setting.

You may also adjust the clock time manually and turn off the automatic time update (Auto Sync) when connected with the Internet. Refer to **Advanced Settings** on page 27 for more information.



Using the alarm clock

To set the wake time and sound:

1. Press and hold **ALARM** until the hour time of the alarm clock is highlighted (reversed color) on the display.

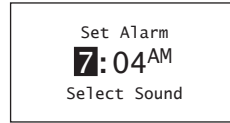

2. Press **▲** or **▼** to select the wake hour time.
3. Press **▶▶** to shift to minute time.
4. Press **▲** or **▼** to select the wake minute time.
5. Press **▶▶** to shift to AM/PM.
6. Press **▲** or **▼** to select between AM and PM.
7. Press **▶▶** to shift to **Select Sound** and then press **SELECT**.
8. Press **▲** or **▼** to highlight one of the sources of wake sound:
 - Buzzer
 - AM Presets
 - FM Presets
 - Slacker Presets
 - Internet Presets

Read relevant sections (e.g. Slacker Radio) in this user manual to understand how to preset stations.



9. Press **SELECT** on the highlighted source of wake sound and then press **▲** or **▼** to select the desired sound or preset item.
10. Press **SELECT** to confirm the selected item as the wake sound.
 - When the radio loses electricity, the alarm clock will be powered by the batteries inserted at the base (refer to page 9). The wake sound selected will be reverted to the default buzzer.
 - When the selected sound is no longer available, the default buzzer will sound.

Clock and alarm

To activate or deactivate the alarm clock:

1. Press **ALARM**.
2. If alarm is off, press **ALARM** again to activate it.
 - If alarm is already on, press **ALARM** again to deactivate it.

To turn off the alarm clock when it sounds:

- Press **ALARM** or **ON/STANDBY** to turn off the alarm clock. It will sound again on the next day if settings have not been changed.

OR

- Press **SLEEP/SNOOZE** to turn off the alarm clock temporarily for extra sleep time. The alarm will sound again after 10 minutes.

OR

- The alarm clock will turn off automatically after 60 minutes without pressing any button.

Sleep mode

You can set the radio to play for a set length of time before turning off automatically.

1. Press **SLEEP/SNOOZE** to turn on the Sleep mode while listening to the radio.

Sleep: 15 min

Press again to add
more time

- The default time is 15 minutes.
 - If the radio is off, press **SLEEP/SNOOZE** to turn on the Sleep mode with the last used channel.
2. If necessary, press **SLEEP/SNOOZE** again to add extra sleep time up to 90 minutes. Each press of the button will add 15 minutes.
 - The remaining time before turning off automatically will show at bottom right of the clock display, replacing the weather information.
 - Select **OFF** (press **SLEEP/SNOOZE** once more after 90 min) if you decide not to use the sleep mode. The radio will turn off.
 - To cancel the Sleep mode sooner, press **ON/STANDBY**.

Slacker Radio

Slacker Radio is a premium, streaming content provider partner which offers "personalization" through the use of selectable "Love it" and "Ban it" buttons. It also uses artist recommendation and related artists to further assist discovery of music and enjoyment of stations.

You can listen to Slacker Radio with an anonymous account for a limited time only with some limited functionality. Register a FREE account in order to take full advantage of the station creation and song rating system. A premium subscription is also available, but not required. For more information regarding Slacker Radio accounts, please visit www.slacker.com.

To use your Slacker account, the account information in the radio (refer to **Account Info** on page 27) must match your Slacker account information online.



Accessing Slacker Radio

- Press **SOURCE** repeatedly to select **Slacker Radio**.
- OR
- Press **▲** or **▼** to highlight **Slacker Radio** in the Source menu and then press **SELECT**.

Listening to Slacker Radio

To select a station (free account users):

1. Press **▲** or **▼** to highlight a station genre and then press **SELECT**.

SLACKER RADIO	
Slacker spotlight>	
Top Stations >	
Alternative >	
Blues >	

- Some genres may contain sub-genres for selection.
- Custom stations can only be created through the Slacker website.

2. While a station is highlighted, press **SELECT**. The selected station will start to play.

SLACKER:	
Alternative	
Pearl Jam	
3:04/4:27	
Next: The Chiefs	

- Press **⏸** to pause or resume playback.
3. Press **⏭** to skip to the next song.
 - Free account limits to 6 skips per hour per station.

To select a station (Premium account users):

1. Press **▲** or **▼** to highlight **Station** or **Library** and then press **SELECT**.

SLACKER PREMIUM	
Stations >	
Library >	

2. When **Station** is selected, press **▲** or **▼** to highlight a station genre and then press **SELECT**.
- When **Library** is selected, press **▲** or **▼** to highlight an artist and then press **SELECT** to further select a song from the selected artist.



Slacker Radio

To store the current station as a preset:

1. Select a station.
2. Press and hold **1, 2, 3, 4, 5** or **6** on top of the radio until a beep sound is heard to store the current station to that preset button.
 - To listen to a preset station, press **1-6**.
 - To edit a preset station, repeat the steps above to overwrite the previously stored station.
 - You can assign a preset station as the wake sound of the alarm, refer to page 17 for more information.

To mark a song as favorite:

Press  while listening. The current song will be marked as favorite.

- The  button will illuminate if the same song is heard next time.
- Songs marked as favorites will appear in the playlist more often.
- To unmark the song as favorite, press  while the same song is playing.

To create an artist station based on the current artist:

Press and hold  while listening. A new artist station will be created using the currently playing artist.

- The new station will be named using the artist's name and the term **Radio**.
- The newly created artist station will begin playback.
- It is also possible to create an artist station by pressing  and selecting from the tag menu.



To ban a song in the current station:

Press  while listening. The current song will be marked as banned.

To ban an artist in the current station:

Press and hold  while listening. The current artist will be marked as banned.

Tag Options

Two options are available while you are listening to a Slacker Radio station as you press . Press  or  to highlight an option in the Tag Options menu and then press **SELECT** to proceed.



- **Create Station**

To create a new station using the currently playing artist as the seed song (this function is the same as pressing and holding  while listening).

- **Send to Alarm**

To assign the station in general to be used as the alarm clock wake sound.

To further manage your artist stations, unmark the banned songs or banned artists, please login your Slacker account (www.slacker.com) from your PC for advanced station management.



Internet Radio

With Internet radio, you can listen to music, news, sports, weather or talk radio in other countries or from your home town. It offers the most music selections from around the world and most stations are free.

Accessing Internet Radio

- Press **SOURCE** repeatedly to select **Internet Radio**.
OR
- Press **▲** or **▼** to highlight **Internet Radio** in the Source menu and then press **SELECT**.

Listening to Internet Radio

To select a station:

Internet Radio stations are categorized according to music genre, talk nature and geographical location.

1. Press **▲** or **▼** to highlight a category or sub-category and then press **SELECT**.



- **My Genres** – your favorite genres together in one place for easier navigation
 - **My Favorites** – a list of your favorite Internet Radio stations
 - **Music** – music stations categorized by genre and sub-genres (e.g. Blues, Hip Hop)
 - **Talk** – talk-specified stations categorized by talk natures (e.g. Business news, Religion)
 - **My Local** – a list of local Internet radio stations selected according to the ZIP code provided by the user
 - **By Region** – music stations categorized by geographical regions
2. While a station is highlighted, press **SELECT**. The selected station will start to play.

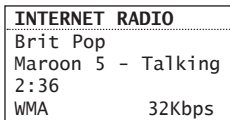

To store the current station as a preset:

1. Select a station.
2. Press and hold **1, 2, 3, 4, 5** or **6** on top of the radio until a beep sound is heard to store the current station to that preset button.
 - You can store up to 6 stations in each genre.
 - To listen to a preset station, press **1-6**.
 - To edit a preset station, repeat the steps above to overwrite the previously stored station.
 - You can assign a preset station as the wake sound of the alarm, refer to page 17 for more information.

To store the current station as My Favorites:

Press **♡** while listening.

Alternatively:

1. Press **☒**.
2. Press **▲** or **▼** to highlight **Add to Favorites** and then press **SELECT**.

To listen to a station in My Favorites:

Select a station from **My Favorites** in the main menu of Internet Radio and then press **SELECT** to start playback. (Read **To select a station** for more information).

To remove a station from My Favorites:

Press **☒** while listening to a favorite station.

Internet Radio

To assign the current station as the wake sound of the alarm clock:

1. Press **☰**.
2. Press **▲** or **▼** to highlight **Send to Alarm** and then press **SELECT**.

Recording Internet Radio

Warning! Use of the recording feature is for personal use only. (Files can not be transferred or moved from the internal memory.)

To record the current station:

1. Press **O** to start recording.

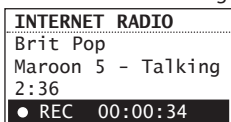

2. Press **O** to stop recording.
 - Recording will be stored in the internal memory of the radio.
 - For playback, please refer to **Internal Memory** on page 24.
 - The radio names each recording *<Station Name>_<Month_Date>_<Time Stamp>*. For example: JazzMan_1_21_445.

Adding Internet Radio stations

To add Internet Radio stations:

Please visit www.rcainfiniteradio.com/portal and login to your user account to add new stations under **My Favorites**.

FM/AM Tuner

FM/AM antenna

- For FM reception, uncoil the FM antenna at the back of the radio, ensuring it is fully extended (you may even want to tape it to the wall behind the radio if possible. The higher the better.)
- For AM reception, connect the AM antenna loop to the back of the radio. Rotate the AM loop antenna for better reception.

Accessing FM/AM Radio

- Press **SOURCE** repeatedly to select **FM Tuner** or **AM Tuner**.
OR
- Press **▲** or **▼** to highlight **FM Tuner** or **AM Tuner** in the Source menu and then press **SELECT**.

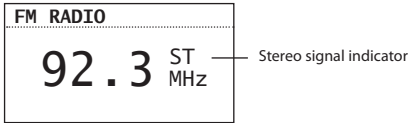

Listening to FM/AM Radio

To select a station:

1. Press **◀** or **▶** to adjust the frequency.
2. Press and hold **◀** or **▶** until the radio beeps to start searching through the frequency range. The radio stops searching when it detects the next station.

To store the current station as a preset:

1. Select a station.
2. Press and hold **1**, **2**, **3**, **4**, **5** or **6** on top of the radio until a beep sound is heard to store the current station to that preset button.
 - To listen to a preset station, press **1-6**.
 - To edit a preset station, repeat the steps above to overwrite the previously stored station.
 - You can assign a preset station as the wake sound of the alarm, refer to page 17 for more information.

To assign the current station as the wake sound of the alarm clock:

1. Press **☰**.
2. Press **▲** or **▼** to highlight **Send to Alarm** and then press **SELECT**.

Recording FM/AM Radio

Warning! Use of the recording feature is for personal use only. (Files can not be transferred or moved from the internal memory.)

To record the current station:

1. Press **O** to start recording.

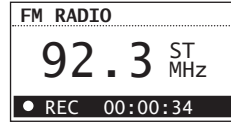

2. Press **O** to stop recording.
 - Recording will be stored in the internal memory of the radio.
 - For playback, please refer to **Internal Memory** on page 24.
 - The radio names each recording `<Source><Station Frequency>_<Month_><Date>_<Time Stamp>`.
For example: FM99.5_1_21_1245.

Internal Memory

The radio's internal memory stores up to 10 hours of recordings from Internet Radio and FM/AM Tuner.

Accessing Internal Memory

- Press **SOURCE** repeatedly to select **Internal Memory**.
OR
- Press **▲** or **▼** to highlight **Internal Memory** in the Source menu and then press **SELECT**.

Listening to recordings

1. Press **▲** or **▼** to highlight a recording and then press **SELECT**.

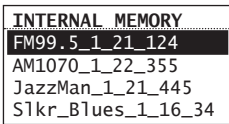

2. Press **▲** or **▼** to highlight **Play** and then press **SELECT** to start playback.
3. Press **⏸** to pause or resume playback.
4. Press **⏭** to skip to the next recording.
5. Press **⏮** to skip within the beginning 4 seconds of the current recording to skip to the previous recording. Otherwise, you will return to the beginning of the current recording.

Deleting recordings

1. Press **▲** or **▼** to highlight an unwanted recording and then press **SELECT**.
2. Press **▲** or **▼** to highlight **Delete** and then press **SELECT**.

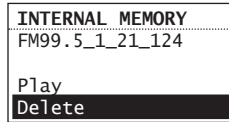

3. Press **▲** or **▼** to highlight **Yes** in the confirmation screen and then press **SELECT**.

To delete all recordings:

1. In the list of recordings, press **▲** or **▼** to highlight **Delete All** and then press **SELECT**.

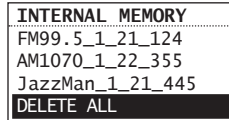

2. Select **Continue** in the confirmation screen and then press **SELECT**.
- You can also clear the internal memory from the Settings menu. Refer to **Advanced Settings** on page 27 for more information.

USB Input

The radio can play back music files (mp3, wma and RealAudio (RA8 and G2) formats) stored on an external USB device connected to it. The USB connection port is located at the back of the radio.

Accessing USB Input mode

- Press **SOURCE** repeatedly to select **USB Input**.
OR
- Press **▲** or **▼** to highlight **USB Input** in the Source menu and then press **SELECT**.

Listening to music files

1. Press **▲**, **▼**, **⏪** or **⏩** to browse through the directory of the USB device and select a music file by pressing **SELECT**.

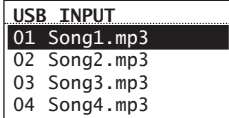

- Press **⏩** or **SELECT** to enter a folder.
 - Press **⏪** to exit from a folder.
2. Press **▲** or **▼** to highlight **Play** and then press **SELECT** to start playback.
 3. Press **⏸** to pause or resume playback.
 4. Press **⏩** to skip to the next recording.
 5. Press **⏪** to skip within the beginning 4 seconds of the current recording to skip to the previous recording. Otherwise, you will return to the beginning of the current recording.

Deleting files

1. Press **▲** or **▼** to highlight an unwanted file and then press **SELECT**.
2. Press **▲** or **▼** to highlight **Delete** and then press **SELECT**.

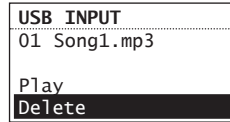

3. Press **▲** or **▼** to highlight **Yes** in the confirmation screen and then press **SELECT**.

Weather

Weather broadcast

Your radio includes a complimentary 4 year weather subscription from WeatherBug®



A digital weather broadcast is available including:

- Text-to-speech reading of weather forecast for the ZIP code associated with the radio (can be turned on or off in the Settings menu). Audio playback will pause during reading.
- On screen display of conditions including current temperature, high and low temperatures of the day, current weather condition, humidity and wind conditions.
- Graphical display of weather conditions for 3-day forecast:

	Unknown
	Sunny/clear
	Mostly sunny
	Partly cloudy
	Mostly cloudy
	Cloudy
	Clear (night)
	Mostly clear (night)
	Partly cloudy (night)
	Mostly cloudy (night)
	Hazy
	Hazy (night)
	Rain
	Heavy rain
	Thunderstorms
	Severe thunderstorms
	Sleet
	Frozen mix

	Snow
	Heavy snow
	Windy
	Fog

To check the weather of current day:

Press **WEATHER** once.

WEATHER: 46290
Current: 67(68/51) F
Partly Cloudy
Humidity: 50%
Wind: 7 mph

To check the 3-day weather forecast:

Press **WEATHER** twice to check weather forecast for current day and the next two days.

WEATHER: 46290		
Current: 67		
Today	Wed	Thu
68/51	70/50	73/52

To return to the previous audio source or playback screen:

Press **WEATHER** a third time.

Emergency Broadcast System alert

When an Emergency Broadcast System alert is received, the radio will:

- pause current audio playback,
- sound the alert chirp,
- display the emergency warning text on the display,
- use text-to-speech to read the alert

You can select the minimum level of emergency alerts to be notified of by the alert chirp or the text-to-speech reading in the Settings menu.

Settings

Changing radio's settings

To change the radio settings:

1. Press **⏮** to display the Source menu.
2. Press **▲** or **▼** to highlight **Settings** and then press **SELECT**.
3. Press **▲** or **▼** to highlight a setting and press **SELECT** to enter the sub-menu.

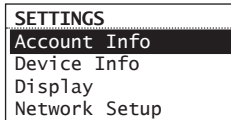

- Repeat this step to browse for more settings and sub-menus.
4. To change setting, press **▲** or **▼** to highlight a desirable option and then press **SELECT** to confirm.

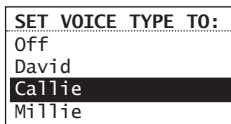

Account info

- To change the login information (username and password) sent by the radio when attempting to login to the Slacker service.
- To edit the ZIP code for Slacker, time and weather functions.

If you have changed your account information through Slacker's website, please also edit the account information in this setting. The information here must match your Slacker account information online.



Device info

To show the firmware version, MAC address and PIN number of the radio. MAC address and PIN are necessary to activate your RCA Infinite Radio accounts.

Display

To change brightness and contrast of the display.

Network setup

To change the network setting of the radio (wired or wireless). Refer to page 11 for more information.

Software updates

To check if newer firmware is available. Follow the instructions on the display for update.

Weather

- To turn on or off the text-to-speech reading when you press the **WEATHER** button.
- To select the gender and accent (US/UK) for the voice used for text-to-speech reading.
- To select the minimum level of emergency alerts to be notified of by the alert chirp.
- To select the minimum level of emergency alerts to be notified of by the text-to-speech reading.

Advanced settings

- **Clock Mode:** to select between **Auto Sync** and **Manual** for clock time update. If **Auto Sync** is selected, the clock time will update every 5 minutes while checking for weather update.
- **Format memory:** to clear all recordings in the internal memory.
- **Reset to defaults:** to reset menus to factory defaults. The following settings will be reset:
 - Slacker username
 - Slacker password
 - Display options
 - Language selection
 - Zip code entry
 - Network connection setup
 - Clock
 - Alarm
 - Weather alert level
 - Text-to-speech options
 - Demonstration mode
 - Recordings in Internal Memory will NOT be erased
- **Set Language:** to change the language of the display.

Some menus may require character input, refer to page 16 for tips on inputting characters.



More information

Troubleshooting tips

The radio cannot be turned on.

- Plug the AC power adapter securely into the radio and a wall outlet.
- Check the power outlet by plugging in another device.
- Press and hold ON/STANDBY for 10 seconds to reboot the unit.

No sound.

- Increase the volume setting.
- Make sure the headphones are not plugged in.

The radio does not respond to key presses.

- The radio may temporarily cease to function if subjected to electrostatic disturbance. To resume normal operation, it may be necessary to reset the radio by unplugging and reconnecting the power or by removing and reinstalling the batteries in the base of the radio.

Cannot connect the radio to Internet.

- Check if your access point is turned on.
- Check if the wireless enabler is securely and correctly connected.
- *For users of RCA Wi-Fi Enabler:* make sure all the indicators on the Enabler's front panel are lit. If the WPS, MODE, or WIRELESS indicators are off or blinking simultaneously, press and hold the Enabler's **WPS** button for 3 seconds (the MODE LED should start blinking) to rescan your network configuration. The Enabler may restart multiple times during this process and take up to two minutes depending on your network configuration. The MODE LED will stop blinking when this process is completed. Go to **www.rcainfiniteradio.com** for more information.
- Make sure a firewall is not blocking any outgoing ports.
- Make sure the access point does not restrict connections to specific MAC addresses.
- Make sure you have entered the correct password. Password is case sensitive.
- Your wireless Internet connection may exceed the maximum range for reception. Relocate the Internet Radio closer to the wireless access point.
- The network settings of the radio may be incorrect. Check the network settings in Network Setup in the Settings menu.

Clock time is incorrect.

- Refer to Account Info in the Settings menu and make sure you have correctly input your ZIP

code as reference for automatic clock time update.

Weather information is incorrect.

- Refer to Account Info in the Settings menu and make sure you have correctly input your ZIP code as reference for weather information.

Weather information and Emergency Broadcast System alert are not read out.

- Refer to Weather in the Settings menu and make sure you have turned on the text-to-speech reading feature.

The radio connects to the Internet but is unable to play a particular station.

- Check if the station is still broadcasting.
- The station may have reached the maximum number of simultaneous listeners.
- The link to the radio station may be out of date.
- The Internet connection between the radio station server and the radio may be too slow.

Intermittent audio.

- The bandwidth of your wireless LAN may be too low. Move the radio closer to the access point and make sure that there are no obstacles between them.
- The actual transmission speed of digital radio broadcast depends on the service provider (i.e. the Internet radio station).

Cannot skip to the previous song while listening to Slacker or Internet Radio.

- Skipping to the previous song in Slacker or Internet Radio is not available.

Poor FM/AM Tuner reception.

- Check the antenna connection.
- Move antenna.
- Turn off nearby electrical appliances, such as hair dryer, vacuum cleaner and microwave.

Cannot record radio.

- Record feature is only available for Internet Radio, AM and FM Tuner.
- The internal memory of the radio may be full. Remove some of the old recordings.

More information

Cannot play back music files on connected USB device.

- Make sure USB device is securely connected.
- Digital Right Management (DRM) type music files will not be played.
- The radio supports FAT12, 16 and 32 file systems only. Other file systems from Linux, MAC or NTFS are not supported.

The LED of ON/STANDBY button is flashing.

- The LED is flashing (5-second interval) when the unit is being powered by the backup batteries due to electricity supply interruption. Please check your AC power supply.
- If the LED is flashing even faster (3-second interval), this means that the unit is being powered by weak backup batteries. Please replace the backup batteries (refer to page 9). We recommend that you replace the batteries every year (or more often in case of multiple power outages) to avoid low battery power. Otherwise, clock and alarm accuracy may be affected when electricity supply is interrupted.

Cannot stop the demonstration mode.

- To exit the demonstration, press and release in sequence the buttons on top of the radio: preset **1**, then **SLEEP/SNOOZE**, then preset **6**.

My question was not answered here.

- Visit www.rcainfiniteradio.com for an up-to-date list of frequently asked questions.

Further help on Wi-Fi Enabler (for RIR205)

- The RCA Wi-Fi Enabler adds Wi-Fi capability to your existing network. Page 9, step 4 shows you how to connect the RCA Wi-Fi Enabler to your network.
- Your Wi-Fi Enabler comes preconfigured from the factory so normally no changes should be necessary. This information is provided for the more advanced users or for troubleshooting purposes.
- If you encounter problems connecting the radio to the Internet via RCA Wi-Fi Enabler, the settings on the radio may not match the settings on the Enabler. Follow the steps below to configure the settings again.

To find the configuration information of the Wi-Fi Enabler:

- Find the Wi-Fi Enabler's factory configuration information on the white label on the back of the RCA Infinite Radio. This label includes: 1) the Wireless Network's name (SSID), 2) the Security Type, and 3) the password/key.

To check if the configuration information is the same in the radio:

1. Press **⏴** to display the Source menu of the radio. Press **▼** to highlight **Settings** and then press **SELECT**.

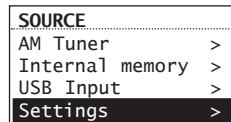

2. In the **Settings** menu, press **▼** to highlight **Network Setup** and then press **SELECT**.
3. In the **Network Setup** screen, press **▼** to highlight **Wireless** and then press **SELECT**.
4. At the warning screen, press **SELECT** while **Continue** is highlighted in the screen below.

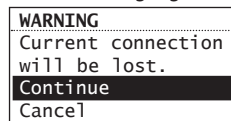

More information

- In the **Network Setup** screen, press ▼ to highlight **Enter SSID** and then press **SELECT**.

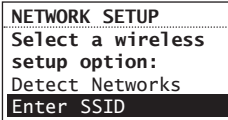

- The **Network Security** screen will be displayed. Confirm the SSID of the Wi-Fi Enabler or re-enter if necessary. When finished, press ▼ to show **DONE** and then press **SELECT** to continue.

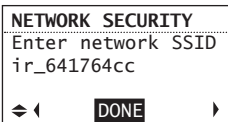

The SSID here is an example only.

- The **Network Security** screen will then show. Press ▼ to highlight **WPA** and then press **SELECT**.

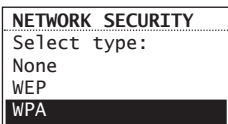

- The **Enter Password/key** screen will be displayed. Confirm the password/key of the Wi-Fi Enabler or re-enter if necessary. When finished, press ▼ to show **DONE** and then press **SELECT** to continue.

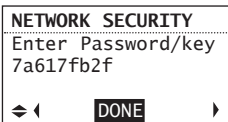

The password/key here is an example only.

- A connection screen will then show to let you know the Network name (SSID) that the radio is connecting to.

- The radio should then connect with the Wi-Fi Enabler and the Internet. If your AR Infinite Radio accounts have not been activated, the radio will then display a **Server Error** message. Please press **SELECT** to continue. You will be asked to enter your postal code before the radio connects successfully.

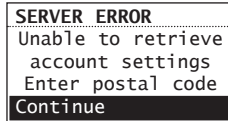

- If you are still unable to connect with the Wi-Fi Enabler, reposition the Enabler and try connecting again. Refer to the **Placement of Wi-Fi Enabler** on page 14 for more information.

More information

Web-based utility of Wi-Fi Enabler

- This section is provided for advanced users that would like to verify their Enabler's configurations via the Enabler's web-based utility.
- The utility can be accessed via your web browser through the use of a computer connected to LAN port of the Wi-Fi Enabler. Refer to page 9, step 4 for more information.
- Major pages in the utility and the page's key functions will be described below. For a basic network setup, most users will not have to use the following screens but this utility may be useful, for troubleshooting.

To access the web-based utility of the Wi-Fi Enabler:

1. Connect the supplied Ethernet cable from the Wi-Fi Enabler LAN port to your computer's Ethernet port. Refer to page 9, step 4 for more information.
2. For PC users running Windows XP, click on **Start**, **Run**, and type **cmd** in the open dialog box and press **Enter**.
- For Mac users running OSx click on the terminal window.
3. For PC users, at the dos prompt, type **ipconfig /all**. This will show you the IP address for your Default gateway (Wi-Fi Enabler).
- For Mac users, in the terminal window, type **ipconfig getpacket en0**.
- A sample of the configuration is shown below:

Ethernet adapter Local Area Connection:

```

Connection-specific DNS Suffix  . : 
Description . . . . . : Broadcom NetXtreme 57xx Gigabit
                          Controller #2
Physical Address. . . . . : 00-12-3F-14-C2-0D
Dhcp Enabled. . . . . : Yes
Autoconfiguration Enabled . . . : Yes
IP Address. . . . . : 192.168.36.11
Subnet Mask . . . . . : 255.255.255.0
Default Gateway. . . . . : 192.168.36.1
DHCP Server . . . . . : 192.168.36.1
DNS Servers . . . . . : 192.168.36.1
Lease Obtained . . . . . : Monday, May 12, 2008 7:05:37 PM
Lease Expires . . . . . : Thursday, May 15, 2008 7:05:37 PM
C:\Documents and Settings\Administrator>
    
```

4. Launch your Web browser and enter the Router's **Default Gateway** address, (in the above example: 192.168.36.1 or 192.168.0.1) in the Address field that was found above and then

press **Enter**. The address depends on whether the Enabler is configured as a Router or as an Access Point (AP) on your system.

5. When the below screen appears, enter **admin** for the User Name and leave the Password field blank, and then click **OK**.

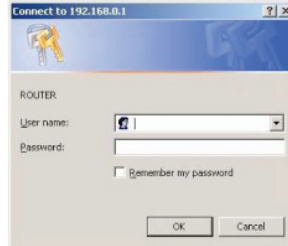

6. The web-based utility's home page will be displayed. You can check the SSID and Security Type here.



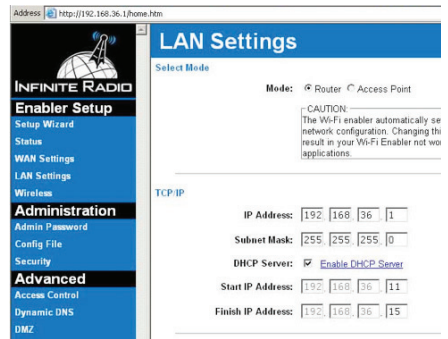

7. Click **LAN Settings** from the left menu to view more configurations (such as IP address, Subnet Mask, etc.).

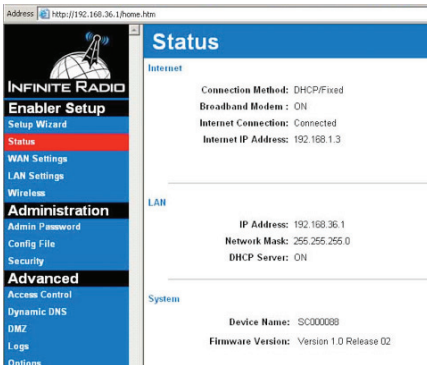

More information

- 8. Click **Status** from the left menu to view the current connection status.



- 9. Click **Wireless** from the left menu to view the wireless settings. The SSID shows here must match the SSID of the radio.
- A quick way to check the SSID on the radio: press , select **Settings**, select **Network Setup**, and then select **Connection Info**.

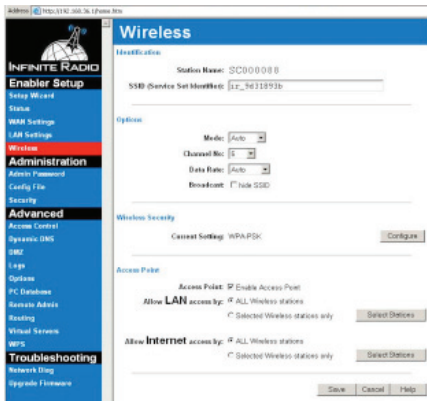

- This screen also shows the Wireless channel that the Enabler is broadcasting on. The default Channel number is set to Auto. In some cases, if there are other wireless networks operating in near proximity on the same channel, the Auto channel mode may not work as expected and Auto may need to be changed to another channel. In the above example the channel was changed from Auto to Channel 6.

- 10. To view the Wireless Security configuration, click **Configure** on the **Wireless** screen.



- In order for the W-Fi Enabler to communicate with the Radio, 1) SSID, 2) Wireless Security Type, and 3) Passphrase must match on both the RCA Wi-Fi Enabler and the radio.
- The SSID on the Enabler can be found on the white label on the side of the Enabler.
- A quick way to check the SSID on the radio: press , select **Settings**, select **Network Setup**, and then select **Connection Info**.

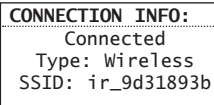

- The wireless security type on the Enabler should be set to **WPA-PSK**. This security type must match the security type on the radio (WPA). Refer to page 29-30 for more information.
- The Passphrase can be found on the white label on the side of the Wi-Fi Enabler and it needs to match the password/key on the radio. Refer to page 29-30 for more information.

More information

Copyright warning

This player is for your personal use only. Unauthorized recording or duplication of copyrighted material may infringe upon the rights of third parties and may be contrary to copyright laws.

Check for updates

Visit www.rcainfiniteradio.com for the latest news and firmware upgrades for our Wi-Fi Internet Radio.

Technical specification

Product: Wi-Fi Internet Radio

Brand: RCA

Model: RIR200, RIR205

Electrical Consumption: 13W

Specifications

Hardware

- Dimensions: 212 mm H, 94 mm W, 154 mm D
- Unit Weight: 790 g (27.9oz) (without batteries)
- Standards: IEEE 802.11g and 802.11b
- Channels: 11 Wi-Fi Channels (US, Canada)
- Ethernet Port: 10/100 RJ-45 compatible
- Power: External 9.0V, 1.4A
- Battery Backup: 3 X AAA Size Batteries
- Display: 2.7" Backlight LCD
- LEDs: On/Standby, two for navigation keys, Love it.
- Internal Memory: 512MB
- Stereo Headphones jack
- USB Connection Jack

AM Tuner section

- Tuning Range: 520KHz to 1710KHz

FM Tuner section

- Tuning Range: 87.5MHz to 107.9MHz

Amplifier section

- Output Power: 2W x 2
- Distortion @ 1KHz: <10% THD

Speakers

- Number: 2
- Size: 40mm (1.56")

Warranty information

Limited warranty

12 Month Limited Warranty

Applies to RCA Audio/Video Products

AUDIOVOX ELECTRONICS CORP. (the Company) warrants to the original retail purchaser of this product that should this product or any part thereof, under normal use and conditions, be proven defective in material or workmanship within 12 months from the date of original purchase, such defect(s) will be repaired or replaced with reconditioned product (at the Company's option) without charge for parts and repair labor.

To obtain repair or replacement within the terms of this Warranty, the product is to be delivered with proof of warranty coverage (e.g. dated bill of sale), specification of defect(s), transportation prepaid, to the Company at the address shown below.

This Warranty does not extend to the elimination of externally generated static or noise, to correction of antenna problems, loss/interruptions of broadcast or internet service, to costs incurred for installation, removal or reinstallation of product, to corruptions caused by computer viruses, spyware or other malware, to loss of media, files, data or content, or to damage to tapes, discs, removable memory devices or cards, speakers, accessories, computers, computer peripherals, other media players, home networks or vehicle electrical systems.

This Warranty does not apply to any product or part thereof which, in the opinion of the Company, has suffered or been damaged through alteration, improper installation, mishandling, misuse, neglect, accident, or by removal or defacement of the factory serial number/bar code label(s). THE EXTENT OF THE COMPANY'S LIABILITY UNDER THIS WARRANTY IS LIMITED TO THE REPAIR OR REPLACEMENT PROVIDED ABOVE AND, IN NO EVENT, SHALL THE COMPANY'S LIABILITY EXCEED THE PURCHASE PRICE PAID BY PURCHASER FOR THE PRODUCT.

This Warranty is in lieu of all other express warranties or liabilities. ANY IMPLIED WARRANTIES, INCLUDING ANY IMPLIED WARRANTY OF MERCHANTABILITY, SHALL BE LIMITED TO THE DURATION OF THIS WRITTEN WARRANTY. ANY ACTION FOR BREACH OF ANY WARRANTY HEREUNDER INCLUDING ANY IMPLIED WARRANTY OF MERCHANTABILITY MUST BE BROUGHT WITHIN A PERIOD OF 24 MONTHS FROM DATE OF ORIGINAL PURCHASE. IN NO CASE SHALL THE COMPANY BE LIABLE FOR ANY CONSEQUENTIAL OR INCIDENTAL DAMAGES FOR BREACH OF THIS OR ANY OTHER WARRANTY. No person or representative is authorized to assume for the Company any liability other than expressed herein in connection with the sale of this product.

Some states do not allow limitations on how long an implied warranty lasts or the exclusion or limitation of incidental or consequential damage so the above limitations or exclusions may not apply to you. This Warranty gives you specific legal rights and you may also have other rights which vary from state to state.

How to make a warranty claim:

- If your product is capable of storing content (such as an mp3 player, digital voice recorder, etc), it is recommended to make periodic backup copies of content stored on the product. If applicable, before shipping a product, make a back up copy of content or data stored on the device. Also, it is advisable to remove any personal content which you would not want exposed to others. IT IS LIKELY THAT CONTENTS AND DATA ON THE DEVICE WILL BE LOST DURING SERVICE AND REFORMATTING. AUDIOVOX ACCEPTS NO LIABILITY FOR LOST CONTENT OR DATA, OR FOR THE SECURITY OF ANY PERSONAL CONTENT OR DATA ON THE RETURNED DEVICE. Product will be returned with factory default settings, and without any pre-loaded content which may have been installed in the originally purchased products. Consumer will be responsible for reloading data and content. Consumer will be responsible to restore any personal preference settings.

Warranty information

- Properly pack your unit. Include any remotes, memory cards, cables, etc. which were originally provided with the product. However DO NOT return any removable batteries, even if batteries were included with the original purchase. We recommend using the original carton and packing materials.
- Include evidence of purchase date such as the bill of sale. Also print your name and address and a description of the defect. Send via standard UPS or its equivalent to:

Audiovox Electronics Corp.
Attn: Service Department.
150 Marcus Blvd.
Hauppauge N.Y. 11788

1-800-645-4994

- Insure your shipment for loss or damage. Audiovox accepts no liability in case of damage or loss en route to Audiovox.
- Pay any charges billed to you by the Exchange Center for service not covered by the warranty.
- A new or refurbished unit will be shipped to you freight prepaid.

What we will do:

Provide you with a new, or at our option, a refurbished unit. The exchange unit is under warranty for the remainder of the original product's warranty period.

For Canada Customers, please ship to:

Audiovox Return Centre
c/o Genco
6685 Kennedy Road,
Unit#3, Door 16,
Mississauga, Ontario
L5T 3A5

Illustrations contained within this publication are for representation only and subject to change.

The descriptions and characteristics given in this document are given as a general indication and not as a guarantee. In order to provide the highest quality product possible, we reserve the right to make any improvement or modification without prior notice. The English version serves as the final reference on all products and operational details should any discrepancies arise in other languages.



Audiovox Electronics Corp.
150 Marcus Blvd, Hauppauge, NY 11788
1-800-878-5779
© 2008 Audiovox Electronics Corp.
Trademark(s) ® Registered
Marca(s) ® Registrada(s)
Marque(s) ® Déposée(s)
www.rcaaudiovideo.com

v2.0

36